

enhanced
vision

acrobatTM



Users Manual

Congratulations on your purchase of the Acrobat LCD. Enhanced Vision products are designed to give you the highest quality and convenience available.

The Acrobat LCD product can enable people with low vision to read, write and to see objects at any distance. The unique design of this product provides the ultimate in flexibility and offers a large range of magnification with multiple viewing options that make reading easier than ever. The Acrobat LCD is a fully integrated solution, offering the advantage of a built-in LCD screen.

Prior to using this system, please carefully read and follow the instructions provided within this booklet. A thorough understanding of the functionality will allow you to fully benefit from the flexibility and great features of this device.

If you have any questions, please contact the eyecare professional or the supplier from whom you have acquired the unit.

FCC COMPLIANCE NOTICE

This device complies with Part 15 of the FCC Rules. Operation is subject to the following two conditions: (1) This device may not cause harmful interference, and (2) this device must accept any interference received, including interference that may cause undesired operation.

This equipment has been tested and found to comply with the limits for a Class B digital device, pursuant to Part 15 of the FCC Rules. These limits are designed to provide reasonable protection against harmful interference in a residential installation. This equipment generates, uses, and can radiate radio frequency energy and, if not installed and used in accordance with the instructions, may cause harmful interference to radio communications. However, there is no guarantee that interference will not occur in a particular installation. If this equipment does cause harmful interference to radio or television reception, which can be determined by turning the equipment off and on, the user is encouraged to try to correct the interference by one or more of the following measures:

- Reorient or relocate the receiving antenna.
- Increase the separation between the equipment and receiver.
- Connect the equipment into an outlet on a circuit different from that to which the receiver is connected.
- Consult the dealer or an experienced radio/TV technician for help.

Unauthorized changes or modification to this system can void the user's authority to operate this equipment.

If your Low Vision device has an option to connect to a TV, it must be used with shielded interface cables in order to meet FCC emissions limits for Class B digital devices. It is the responsibility of the user to use the shielded interface cables supplied with the equipment.

Important Safety Precautions	4-8
Acrobat LCD	
Acrobat LCD Package Contents	9-10
Acrobat LCD Setup	11
Using Acrobat LCD	12-28
Advanced Programming	29-30
Troubleshooting	30
Specifications	31
Warranty Statement	32
Other Enhanced Vision Products	33-36
Contact Information	36

IMPORTANT SAFETY PRECAUTIONS

For your safety and to obtain the most benefit and life from the Acrobat LCD, please read these safety precautions very carefully.

The Acrobat LCD is designed to enlarge and enhance images in order to improve the quality of life for people who are visually impaired. The extent to which this product can improve the ability to see images depends on a person's individual condition and level of visual impairment.

The Acrobat LCD is not designed to restore vision, correct eye conditions or halt degenerative vision loss. An eyecare professional can determine the usefulness and suitability of the Acrobat LCD for a patient's individual condition. Please follow these safety precautions:

- Use the Acrobat LCD on a stable, level surface such as a solid desk or table, according to its intended design specifications.
- Avoid placing the Acrobat LCD on an unstable table, cart or stand. It may fall causing serious damage to the unit or bodily injury to the user.
- Use the Acrobat LCD indoors only – it should NOT be exposed to extreme or rapid changes in temperature or humidity. Do not place the Acrobat LCD near a radiator, heater or areas exposed to long hours of direct sunlight.
- Always place the power cord away from traffic areas to avoid damage of power supply.
- Prevent the risk of electrical shock by NOT attempting to disassemble the unit. Please refer all service to an authorized repair facility.

To Move the Acrobat LCD to Another Location

- Use caution if you are repositioning the Acrobat LCD a short distance across a desk or table. Make sure you do not pull on any power cords or connector cables.

Caring for the Acrobat LCD

- Always turn the power OFF on the Acrobat LCD when the system is not in use.
- Always turn the power OFF before cleaning the Acrobat LCD.
- Clean the Acrobat LCD with a soft dry cloth or an electrostatic dusting wipe. DO NOT use liquid cleaners on its plastic surfaces.
- Clean the lens glass as needed with the lens cloth provided within the Acrobat LCD's packaging (See figure 1).



Figure 1

- Follow all warnings, cautions, and instructions marked on the product.
- The attached power cord is a disconnect device for electrical equipment. The socket-outlet should be installed near the equipment and be easily accessible.
- This product is equipped with a 3-wire grounding type plug as a safety feature. This plug has a third (grounding) pin and can only be plugged into a grounding-type power outlet. If necessary, contact an electrician to replace your power outlet with a grounding-type power outlet.
- Do not use the Acrobat LCD in, near or around water. The Acrobat LCD is not designed to offer protection against contact with liquids of any kind.
- Do not use the Acrobat LCD near flammable liquids.
- At least once per week, clean the Acrobat LCD with a soft dry cloth or an electrostatic dusting wipe. DO NOT use liquid cleaners on its plastic surfaces. No additional methods of sterilization or cleaning are recommended or required.

- This product contains moving parts. Please use caution when moving the adjustable slide arm or when transporting the Acrobat LCD to avoid possible injury to hands and fingers.

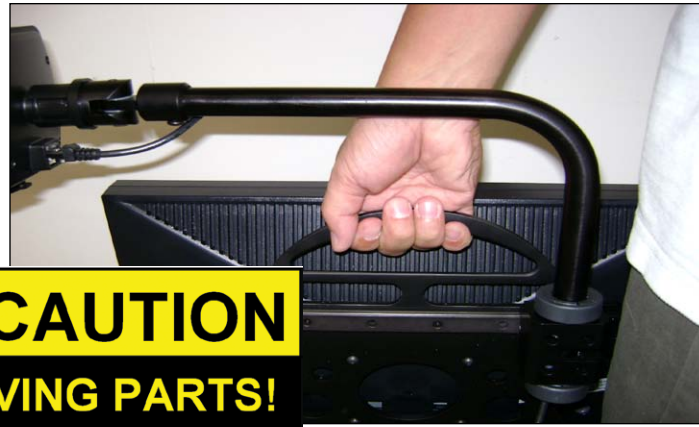

- To avoid personal injury or damage to the Acrobat LCD, do not make any other type of connections to the camera input jacks other than those indicated in the photos below.



Susceptibility to Interference

There may be temporary degradation of the image when the Acrobat LCD is subjected to a strong radio frequency field, electro-static discharge or transient electrical noise. An electro-static discharge (caused by static electricity) may cause the screen to go blank. If this happens, switch the unit off and on again.

Medical Compliance Warnings

- Electromagnetic compatibility: The use of accessories and cables other than those specified by Enhanced Vision may result in increased emissions or decreased immunity of the Acrobat LCD.
- Placement of equipment: The Acrobat LCD should not be used adjacent to or stacked with other equipment.

ACROBAT LCD PACKAGE CONTENTS

All required accessories for operation are included in your Acrobat LCD package.

Acrobat LCD is comprised of the following items and features:

1. 19", 22" or 24" LCD Screen: displays high quality image
2. Camera: rotates 340 degrees to capture and enlarge the image
3. Carrying Handle: used for lifting the Acrobat LCD
4. Zoom Lens: used up close high magnification
5. Arm: rotating arm that holds the camera
6. Lock: used to lock arm from sliding horizontally

Accessories included:

7. Remote Control: (batteries included): allows the user to control the Acrobat LCD functions from a distance
8. Lens Cloth: permits cleaning of the LCD display

Accessories NOT included:

9. Rolling Case (optional): Provides protection for the Acrobat LCD and makes transportation even easier
10. VGA toggle box (optional): Allows the display of the Acrobat LCD to be shared along with a standard VGA output of a computer and permits switching between either source
11. X-Y Table: X-Y table and Mini X-Y table are available for your Acrobat, place underneath your acrobat camera and make reading even easier!



ACROBAT LCD SETUP

1. Unpacking and transporting the Acrobat LCD

During unpacking and transporting, be sure to lift the Acrobat LCD by the built-in carrying handle. Do not attempt to lift or carry the LCD by the base. (See Figure 1)

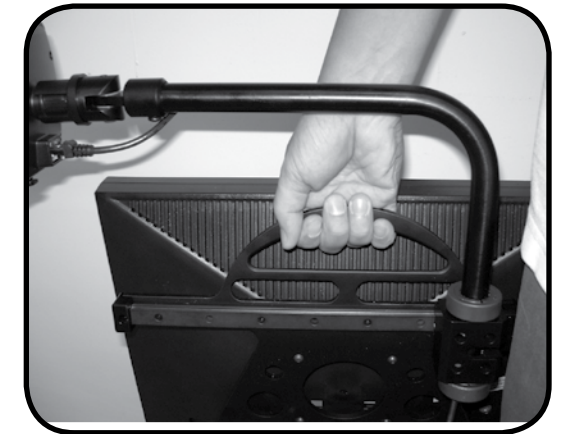

Figure 1

2. Setup the Acrobat LCD

Place the Acrobat LCD on a flat, level surface such as a table or desk.

3. Connect the AC power

Connect the attached power cord to an available wall outlet. (See Figure 2) To offer additional protection during an electrical storm, a surge protector may also be used and is recommended.



Figure 2

4. Turn the power on

On the rear, right side of the Acrobat LCD, flip the switch from the 0 to I position (See Figure 3). The LCD screen and Acrobat Camera will automatically turn ON in a few seconds. An image of what the Camera is pointing at should appear on the LCD screen.



Figure 3

Turn the power OFF by flipping the same switch back to the 0 position. However, leave the power ON for this training section.

USING ACROBAT LCD

Adjust the camera position

The Acrobat LCD camera is attached to a specially designed arm that allows the camera to slide left or right, or to pivot in multiple directions. (See Figure 1, 2, 3 and 4)



Figure 1



Figure 2

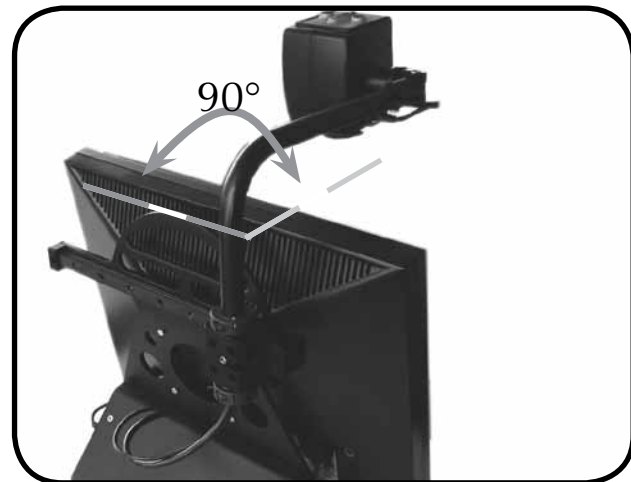

Figure 3

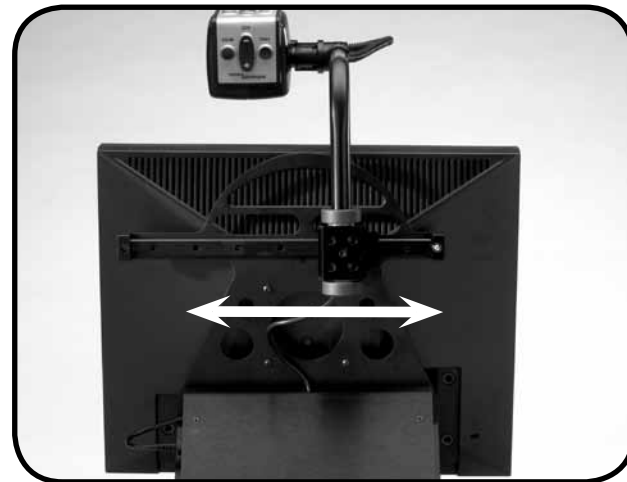

Figure 4

Adjusting the Viewing Angle

The Acrobat LCD Camera rotates 340 degrees, providing unsurpassed flexibility for the visually impaired. Do NOT force the camera beyond its 340-degree angular range as this may damage the unit.

The Acrobat LCD may be used to see objects in the distance, viewing oneself and reading or writing. To change the viewing mode, simply turn the position of the Camera by rotating it on the arm.

Distance Viewing Mode

The camera can rotate forward to capture people, objects and scenery. "Distance Viewing" is displayed in the upper-left corner of the screen when changing to this viewing angle. Be sure to open the Reading Lens for Distance Viewing (See Figure 1).

This Distance mode enables up to 25X magnification for objects 3 feet away. In this mode, although the camera can view objects at an infinite distance, the recommended distance from camera to the distant object is within 3-30 feet to achieve maximum magnification benefit (See Figure 2).



Figure 1

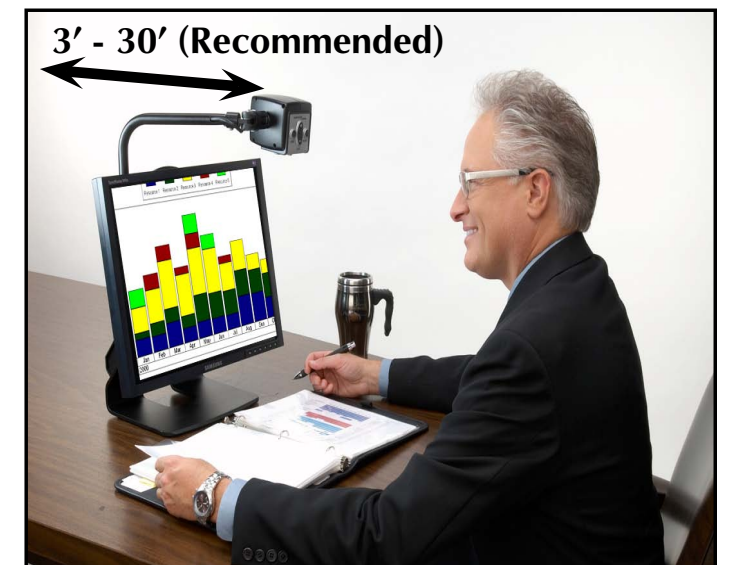

Figure 2

Self Viewing Mode

The Camera can be rotated backwards to provide you with the equivalent of a full-length mirror. "Self Viewing" is displayed in the upper-left corner of the screen when changing to this viewing angle. In this position, you can use the Acrobat LCD to help you put on make-up, shave or perform other personal hygiene (See Figure 1).

For optimum clarity, use the Zoom Lens and position yourself between 7.5"-22" away from the Camera.



Figure 1

Reading and Writing Mode

The Camera can be adjusted downward for reading, writing and enjoying crafts or other hobbies (See Figure 1). This makes it ideal for classroom use. When the camera is rotated downward, "Reading-Mode" is displayed in the upper-left corner of the screen.

The Acrobat LCD can slide freely, left or right, along the specially designed bracket mechanism.

It is best to close the Zoom Lens when objects are placed 12"-19" away from the Camera for optimal viewing clarity.

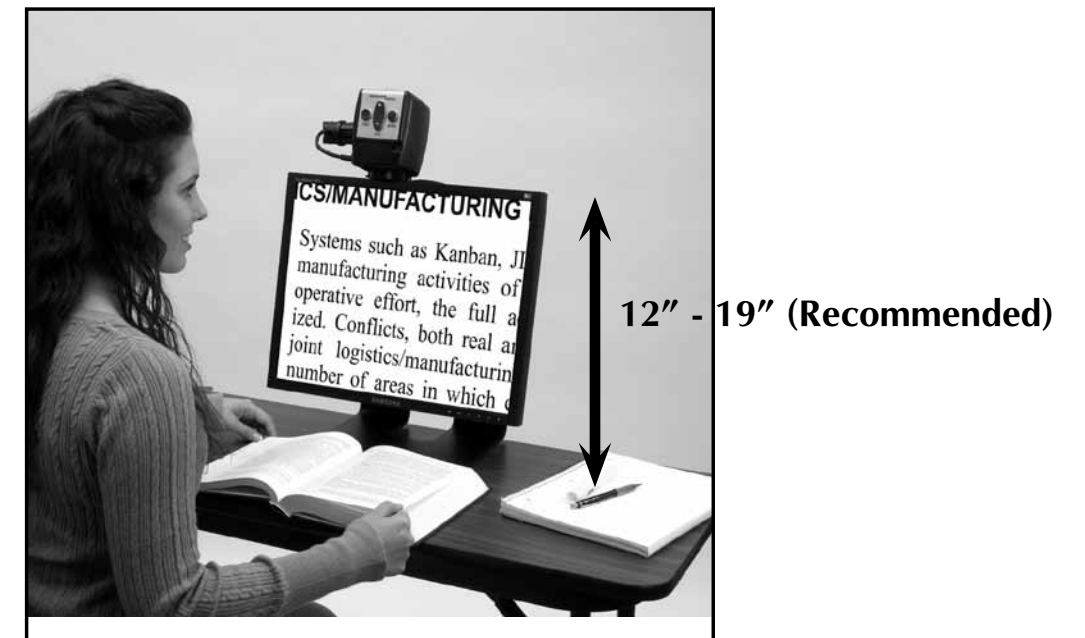

Figure 1

Adjusting Magnification

The Acrobat LCD offers a large range of magnification capabilities. The following directions can be used with the Remote or Camera (See Figure 1 & 2).

1. To adjust the magnification press and hold the + or - buttons located on the Remote or Camera until you reach your desired magnification.
2. "Zoom In" will appear in the upper left corner of your monitor when you are increasing magnification. "Max Zoom," will appear at the maximum magnification.
3. "Zoom Out" will appear in the upper left corner of your monitor when you are decreasing magnification. "Min Zoom," will appear at the minimum magnification.

NOTE: The extent of the magnification is dependent upon the distance of the Camera to the object.

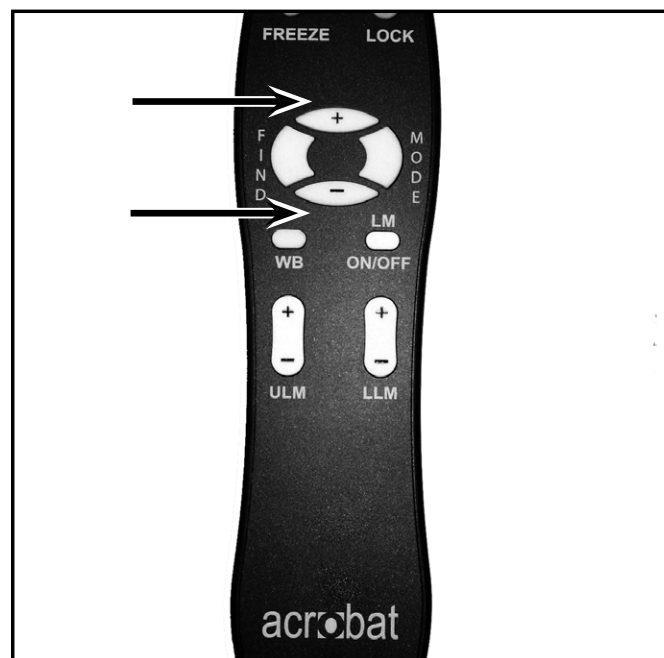

Figure 1



Figure 2

Changing the Viewing Mode

The Acrobat LCD was designed to provide optimum viewing for people with certain visual conditions by offering a range of choices in both text and background colors. In addition, it will remember the viewing mode selected for each viewing angle. Use the Mode key (See Figure 1 & 2) to toggle between full color viewing, Black and White, enhanced positive, enhanced negative, and your 5 favorite color select modes. The 5 favorite color select modes can be modified to any of the 28 color select options by following the instructions provided on page 24. The following directions can be used with the Remote or Camera.

Adjusting Viewing Modes

1. You can choose a viewing mode by pressing the "Mode" button on the Remote or Camera (See figure 1 & 2).
2. Each push will allow you to cycle through all seven viewing modes (See next page).

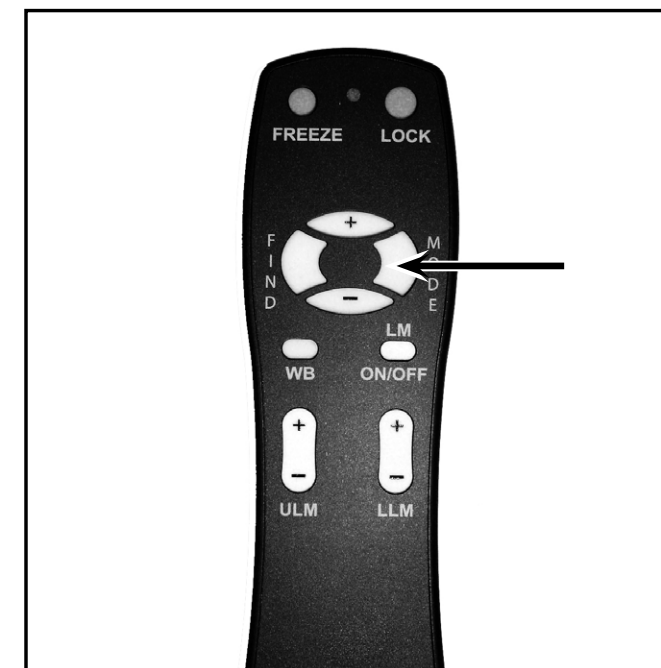

Figure 1

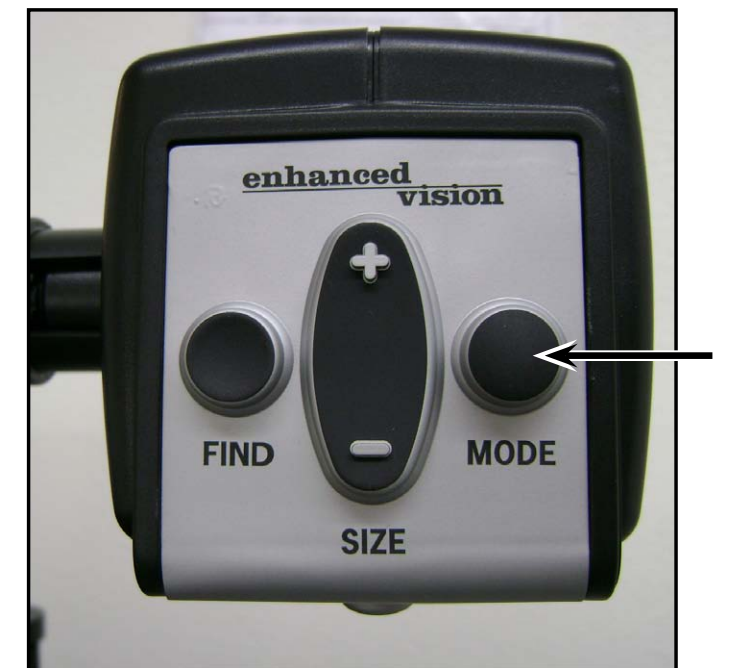

Figure 2

Viewing Modes

Full Color Image

This mode gives a true color representation of the image being magnified.

Black-and-White Image

This mode gives a black and white representation of the image being magnified.

Enhanced-Positive Image

This mode provides a white background with black text. It increases the contrast to offer crisp text images for reading.

Enhanced-Negative Image

This mode provides a black background with white text. It increases the contrast to offer crisp text images for reading.

Color Select 1

In factory default this mode provides a blue background with yellow text. This is one of the most commonly used color combinations. To change this mode to any of the 28 available follow the instructions on page 24.

Color Select 2

In factory default this mode provides a black background with green text. To change this mode to any of the 28 available follow the instructions on page 24.

Color Select 3

In factory default this mode provides a black background with yellow text. To change this mode to any of the 28 available follow the instructions on page 24.

Color Select 4

In factory default this mode is turned off. Follow the instructions on page 24 to turn this color mode on.

Color Select 5

In factory default this mode is turned off. Follow the instructions on page 24 to turn this color mode on.

**Crisp, Clear
Text Images!**

Enhanced Positive

**Crisp, Clear
Text Images!**

Enhanced Negative

Adjusting the White Balance with the Remote Control

The color white is often affected by the lighting used in a room. The Acrobat LCD White Balance control allows you to achieve optimum clarity.

The following directions can be used to adjust the White Balance with the Remote:

1. Press the White Balance “WB” button (See figure 1) on the Remote, and wait 2 seconds for the key to become active.
2. Repeat Step 1 to scroll through all four settings.
 - a. W.B. Auto automatically adjusts to the lighting in the room
 - b. W.B. Warm casts a red tone
 - c. W.B. Normal casts a balanced tone
 - d. W.B. Cool casts a blue tone

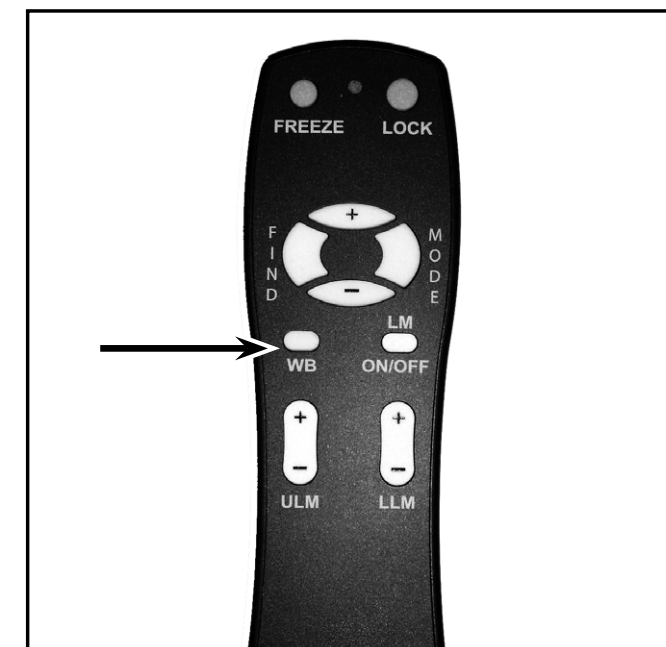

Figure 1

Adjusting the White Balance with the Camera

The following directions can be used to adjust the White Balance from the Camera:

1. Press and hold the Mode button for 3 seconds to "Entering Setup" Menu.
2. Press the + to scroll to "2. White Balance".
3. Press the Mode button to initiate the White Balance feature.
4. Press the +/- to scroll through the four settings.
5. Press the Mode button to exit this feature.

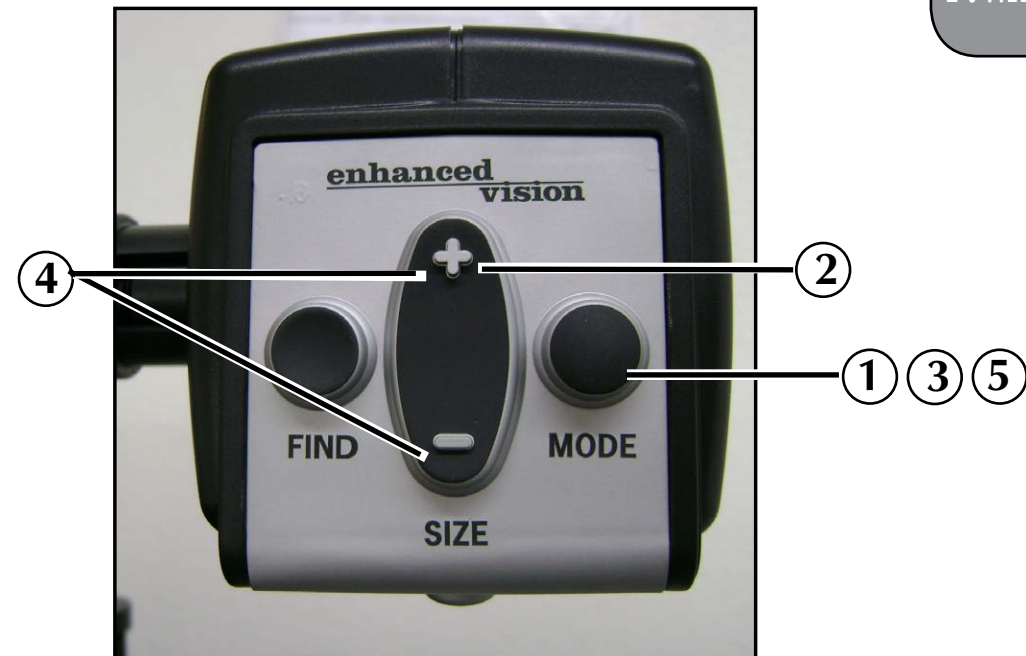

Figure 1

ENTERING SETUP

2.White Balance

1.WHT BAL AUTO
 2.WHT BAL WARM
 3.WHT BAL NORMAL
 4.WHT BAL COOL

Using Line Markers with the Remote control

Line Markers are used to frame an image between two horizontal lines. These lines may be used as a reading guide for long passages of text, as a guide to help keep your place as you move from one side of the page to the other, or just to make writing easier.

The following directions can be used to add/remove Line Markers with the Remote:

1. Press and hold the Line Markers On/Off ("LM ON/OFF") button for at least 1 second.
2. To move the Upper Line Marker press the "ULM+/-" buttons.
3. To move the Lower Line Marker press the "LLM+/-" buttons.
4. To remove Line Markers press and hold the "LM ON/OFF" button for at least 1 second.

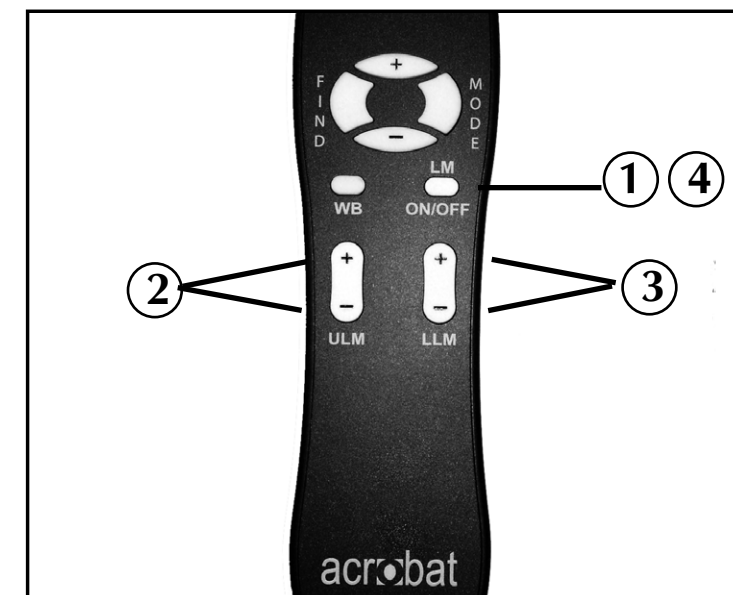

Figure 1

Using Line Markers with the Camera

The following directions can be used to add/remove Line Markers from the Camera:

1. Press and hold the "Mode" button for at least 3 seconds to begin the "Entering Setup" Menu.
2. The menu will automatically indicate "1. Line Markers."
3. Press the "Mode" button.
4. The menu will indicate "1. Line Markers Off"
5. Press the "-" button to activate "Line Markers On."
6. Press the "Mode" button to set line marker.
7. Next the menu indicates "1. Upper Line ADJ"
8. Press the +/- buttons to raise or lower the Upper Line Marker.
9. Press the "Mode" button to set the Upper Line Marker.
10. The menu will now indicate "2. Lower Line Marker."
11. Press the "+/-" buttons to raise or Lower the Lower Line Marker.
12. Press the Mode button to set the Lower Line Marker.
13. To remove Line Markers repeats steps 1-4.
14. Press the "+" button to return to the "1. Line Markers Off" Menu.
15. Press the Mode button to exit the Menu.

ENTERING SETUP

1.Line Markers

1.Upper Line ADJ
or
2.Lower Line Marker

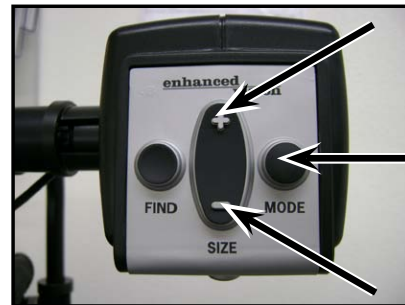

Figure 1

Using Left handed mode

The following directions can be used if you would like to switch between left and right handed mode:

1. Press and hold the "Mode" button for at least 3 seconds to begin the "Entering Setup" Menu.
2. Scroll with the "+" to "3. Left Handed Mode"
3. Press the "Mode" button.
4. The menu will indicate "1. Left Handed Off"
5. Press the "+" button to activate "2. Left Handed On."
6. Press the "Mode" button to set Left Handed mode On or Off.

ENTERING SETUP

3.Left handed Mode

Adjusting Brightness

The following directions can be used if you would like adjust the brightness of the screen:

1. Press and hold the "Mode" button for at least 3 seconds to begin the "Entering Setup" Menu.
2. Scroll with the "+" to "4. Brightness"
3. Press the "Mode" button.
4. Press the "+ or -" button to increase or decrease screen brightness.
5. Press the "Mode" button to set and save the screen brightness.

ENTERING SETUP

4.Brightness

Changing Favorite Color Modes

The Acrobat provides 28 selectable color modes, and allows selecting up to 5 favorites for use, as described on page 17. The following directions can be used to change the favorite color modes on your Acrobat:

1. Press and hold the "Mode" button for at least 3 seconds to begin the "Entering Setup" Menu.
2. Scroll with the "+" to "5. Color Select"
3. Press the "Mode" button.
4. Choose with "+" or "-" which color select mode favorite you would like to change 1, 2, 3, 4 or 5.
5. Press the "Mode" button.
6. Choose if you would like this favorite "On" or "Off" by pressing the "+" or "-".
7. Press the "Mode" button.
8. Press the "+ or -" button to preview each of the 28 available color modes.
9. Press the "Mode" button to select and save the desired favorite color mode.

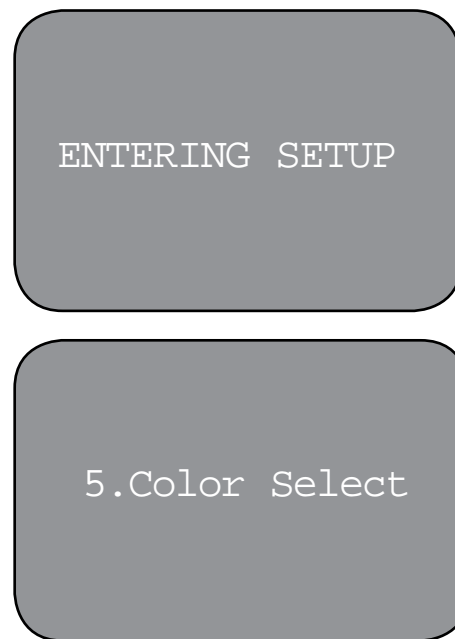

Using the Object Locator

The Acrobat LCD Object Locator feature can help you quickly locate something you're looking for on a page, or a specific part of an object you want to view more closely.

The following directions can be used to locate a desired object with the Remote and Camera:

1. Press and hold down the "Find" button on Remote (See Figure 1) or Camera (See Figure 2).

The Acrobat LCD will automatically zoom out to the widest field of view, and a "target" (as shown in Figure 3) will appear in the center of the monitor screen.

2. Move your work or reading material until you have located the desired item within the "target" area.
3. Release the "Find" button, and it will magnify the item you located within the targeted area.

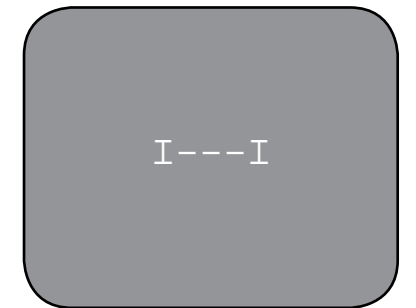

Figure 3



Figure 1



Figure 2

Using Intelligent Focus Lock with the Remote Control

When The Acrobat LCD is turned on, it is automatically set on auto focus. This is the most convenient setting for everyday activities, such as reading from a single page to a book, reading a prescription bottle or working with arts and crafts.

Focus Lock allows you to maintain focus on a specific object at a fixed distance, such as writing. The Acrobat LCD Intelligent Focus Lock feature will automatically refocus on the object you are viewing after changing the magnification size. The Acrobat LCD will keep your writing in focus, rather than your hand when it comes into the Camera's frame.

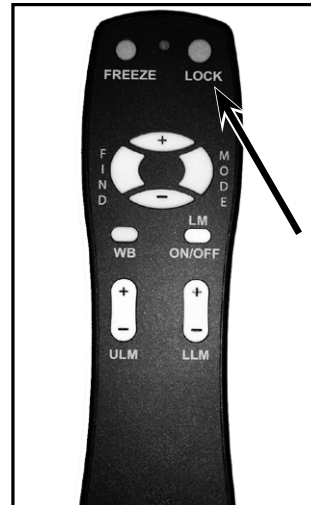

Figure 1

The following directions can be used to apply the Focus Lock feature using the Remote:

1. Place your notepaper, stationery, checkbook or other writing material on the table.
2. Press the "Lock" button on the Remote (See Figure 1).
3. The word "Focus Lock" will appear and remain in the upper left corner of the monitor (See Figure 2).
4. To Return to Auto-Focus, press the "Lock" button on the Remote (See Figure 1).

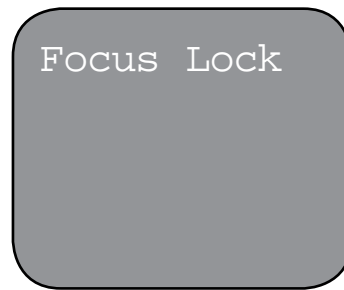

Figure 2

Using Intelligent Focus Lock with the Camera

The following directions can be used to apply the Focus Lock feature using the Camera:

1. Place your notepaper, stationery, checkbook or other writing material on the table.
2. To initiate the Focus Lock feature simultaneously press the "Find" and "Mode" buttons for at least 1 second on the Camera (See Figure 1).
3. The word "Focus Lock" will appear and remain in the upper left corner of the monitor (See Figure 2).
4. To Return to Auto-Focus, simultaneously press the "Find" and "Mode" buttons for at least 1 second on the Camera (See Figure 1).



Figure 1



Figure 2

Using the Freeze Function

Freeze allows you to take a snap shot of what the Acrobat LCD is magnifying in order for you to have extended time to view the image. This is particularly helpful when taking notes in a classroom.

The following directions can be used to apply the Freeze mode using the Remote control only:

1. Press and hold the "Freeze" button for at least 2 seconds (See Figure 1).
2. The picture or video will freeze and in the upper left corner of the screen will indicate "Freeze" (See Figure 2).
3. To release the Freeze mode, press any key or change the viewing angle.

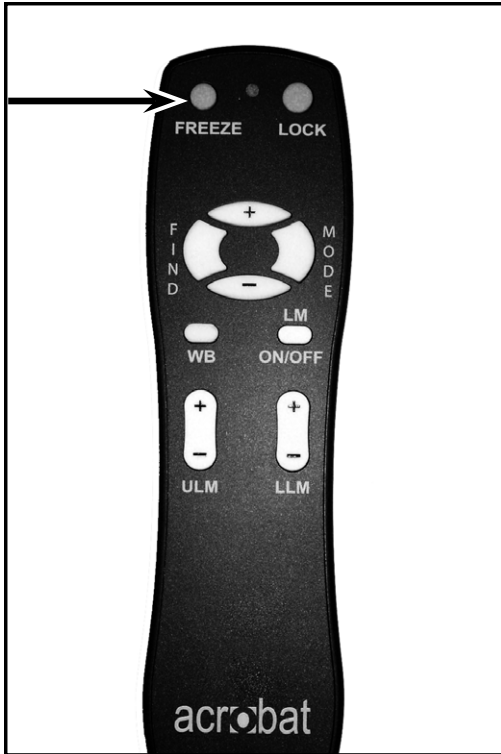

Figure 1



Figure 2

Advanced Programming Options

The Acrobat LCD has advanced capabilities for modifying the programming of the included remote control (when using multiple units) as well as changing the default language used within the setup menus. These settings are completely optional and should not be changed under normal circumstances. The information listed on the following pages are for technical reference purposes only. Please see your Enhanced Vision representative or call our toll-free technical support should it be necessary for you to modify these settings.

Remote Codes

By default, a single remote control (and corresponding remote control code) is factory programmed and used for all Acrobat camera functions. While acceptable for most single-use applications, when 2 or more Acrobats are used within close proximity to each other (lab setting), exclusive remote control over each unit may be desired. Therefore, it is possible to modify the sending/receiving codes of the remote control and Acrobat head for exclusive use, if desired. Up to 15 unique codes can be assigned. For proper communication, both the Remote control (transmit) and camera head (receive) must be set to matching ID codes. Please refer to the chart on the right for more information.

Remote Control (Transmit) Code Change:

- #28 (default/factory reset): **Push MODE and FIND for 3 secs.**
- #15: Push MODE and LLM- for 3 secs.
- #24: Push MODE and ULM- for 3 secs.
- #25: Push MODE and LLM+ for 3 secs.
- #27: Push MODE and ULM+ for 3 secs.
- #07: Push + and FIND for 3 secs.
- #11: Push + and LLM- for 3 secs.
- #14: Push + and ULM- for 3 secs.
- #23: Push + and LLM+ for 3 secs.
- #31: Push + and ULM+ for 3 secs.
- #08: Push - and FIND for 3 secs.
- #09: Push - and LLM- for 3 secs.
- #10: Push - and ULM- for 3 secs.
- #12: Push - and LLM+ for 3 secs.
- #13: Push - and ULM+ for 3 secs.

Language Select

The default language used for the on screen display (OSD) may be changed by accessing the Advanced Programming Features menu on the Acrobat. This is accomplished using a special key combination sequence (4321), accessed by pressing the [+] and [MODE] buttons on Acrobat camera head. Language selection can be adjusted within the second menu level. Please refer to the chart on the following page for detailed reference.

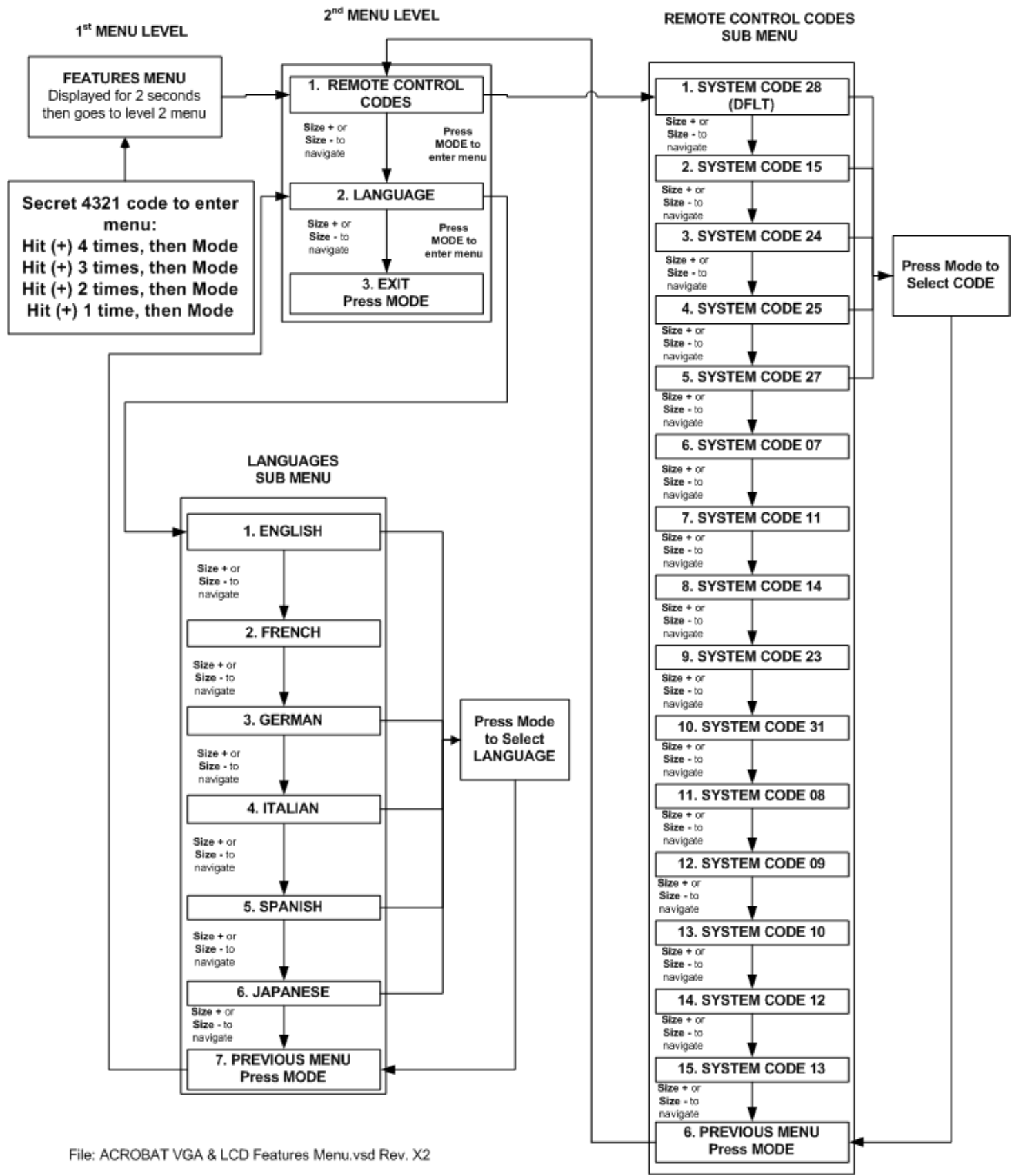

Q. How can I adjust the LCD screen settings?

A. Normally, the setting for LCD brightness, contrast and color have been preset ideally from the factory and do not require modification. However, should these setting become modified accidentally, simply press the recessed [AUTO] button located on the bottom right corner of the LCD to return to factory default settings.



Q. How should I clean the Acrobat LCD?

A. At least once per week, clean the Acrobat LCD with a soft dry cloth or an electrostatic dusting wipe. DO NOT use liquid cleaners on any of the plastic surfaces.

Q. The Remote Control is not functioning properly. What should I do?

A. After ensuring you have fresh batteries installed in the remote control, please reset the remote control back to factory settings. Simply press and hold the [FIND] and [MODE] buttons on the remote control for at least 3 seconds, or until the LED indicator begins to flash. Then, attempt normal operation of the remote control functions.

Q. Can I use the Acrobat LCD with a computer?

A. Yes, the LCD of the Acrobat can be used along with a computer. Although the Acrobat will not magnify computer images, it is possible to use the Acrobat's built-in LCD with either the Acrobat camera or a computer (equipped with a standard VGA connection). This permits a single LCD display to be used for either purpose. An optional VGA toggle box is specifically designed for this application. Please contact your local Enhanced Vision dealer for more details.

ACROBAT LCD SPECIFICATIONS

Product Dimensions:

19" LCD: 21"H x 16"W x 8"D (53cm x 41cm x 20cm)

22" LCD: 21"H x 20"W x 8"D (53cm x 51cm x 20cm)

24" LCD: 21"H x 22"W x 8"D (53cm x 56cm x 20cm)

Product Weight:

19" LCD: 17 lbs. / 7.7 kg (without optional carrying case)

22" LCD: 18.6 lbs / 8.5 kg

24" LCD: 19.6 lbs

Display:

Type: Standard Diagonal LCD

Average lifetime: 10,000 hours

Monitor (common to *19",*22 & *24" models):

Resolution: 1280 x 1024 (19" model)

Resolution: 1680 x 1050 (22" model)

Resolution: 1920 x 1080 (24" model)

Response Rate: 5 milliseconds (19" monitor)

Response Rate: 2 milliseconds (22" & 24" monitor)

*** all monitor specifications subject to change without prior notice**

Camera: Removable CCD, Autofocus

Magnification range:

19" LCD: 2X (minimum) - 65X (maximum)

22" LCD: 2.3X (minimum) - to 75X (maximum)

24" LCD: 3.5X (minimum) - to 81.8X (maximum)

19"/22" Field of View (Near Mode): 6 inches (min); .25 (max)

24" Field of View (Near Mode): 6.5 inches (min); 5.9 (max)

19"/22" Working Distance (Near Mode): 17 inches

24" Working Distance (Near Mode): 16.5 inches

Viewing Modes:

Color, Black & White, High Contrast

Positive/Negative, Digital Color Select (3 modes)

Power Supply:

Input voltage/current: 120-240 VAC / 0.3-0.5A (nominal)

Frequency: 60/50 Hz

Power usage: 60W (nominal)

Equipment Classification (IEC 601-1):

Type of Protection: Class 1

Degree of Protection: Type B

Mode of Operation: Continuous

Operating temperature range: 10-40°C / 50-104°F

Storage/transport temperature range: 0-60°C / 32-140°F

Warranty: 2 years

*Product specifications subject to change without notice

WARRANTY STATEMENT

Enhanced Vision Acrobat Video Magnifier Warranty Policy

Enhanced Vision products are designed to give you the highest quality image, convenient features, ease of use and reliable service. **The Acrobat LCD has been inspected and tested prior to shipping.** Enhanced Vision warrants the Acrobat LCD against defects in material and workmanship under normal use for **two years** from the date of original purchase. Enhanced Vision, at its option, will at no charge either repair the product or replace it during the warranty period. There are no other expressed or implied warranties accompanying this product.

This warranty does not cover: a) Defects or damage from misuse, use in other than normal and customary manner, accident or neglect; b) Defects or damage from improper operation, maintenance, installation, adjustment, alterations or modification; c) Defects or damage from spills of food or liquid; d) All plastic surfaces and all other externally exposed parts that are scratched or damaged due to normal use; e) Damage due to operation of the Acrobat LCD with equipment not supplied by Enhanced Vision.

- You must provide proof of purchase, bearing the date of purchase, in order to receive warranty service.
- Anyone using this product does so knowingly assuming certain risks, due to the need to utilize vision enhancement devices.
- A 2-year extended warranty option is available within 12 months from the date of purchase. Please contact Enhanced Vision for detailed information.

Service Process

In the event that technical support or repair service is needed, please contact your local Enhanced Vision representative or the Enhanced Vision warranty service center.

If warranty service is required, please contact Enhanced Vision at (800)440-9476 Monday through Friday, between 8 a.m. and 5 p.m. Pacific Standard Time (PST) to request a return authorization number. **Warranty repairs will not be accepted without a valid return authorization number.**

You may wish to keep the original product packaging in case warranty service is required. The manufacturer cannot provide packaging for warranty repairs.

NOTE: Please completely fill out and send in the enclosed warranty registration card.

OTHER ENHANCED VISION PRODUCTS

Pebble – Compact, Ultra-Portable Magnification!



The Pebble is a handheld electronic video magnifier that you can take anywhere. Weighing less than 8 ounces, Pebble features a uniquely-designed folding handle and includes both near-viewing and table reading modes. Small enough to fit in your pocket or purse, the Pebble is the ideal companion to provide magnification, on the go. Featuring a built-in 3.5" or 4.3" LCD screen, the Pebble's Freeze-Frame feature allows you to capture any still image and adjust magnification. Up to 28 different viewing modes allow you to choose alternate color combinations based on your personal preference. Pebble can be powered using standard rechargeable batteries (included)

Magnification: 2X – 10X



Flipper – The Ultimate in Flexibility



Read, write, get more out of life! Our innovative camera design lets you magnify in almost any position with images in full color.

Magnification: 1X – 44X*

*With optional stand

Available with Color and Black & White Display Modes



Flipper Panel – Integrated and Portable!



This powerful, portable magnifier integrates the Flipper 225-degree rotating camera with a slim, LCD platform. Powered by an innovative battery pack, the Flipper Panel runs up to 4 hours on a single charge. The discrete camera projects a full-color, auto-focus image on the screen for both near and distance viewing.



Magnification: 1X – 26.4X (with optional stand)

Amigo



Amigo is a truly portable desktop magnifier. Optimal viewing is achieved with a tilting 6.5 inch viewing screen. Amigo provides 3.5 to 14x digital magnification and the lightest weight in its class. Amigo is battery operated and can be taken anywhere.



Merlin LCD & Merlin Plus – Easy to use!



Merlin LCD is a video magnifier that pivots and swivels to the most comfortable viewing position. This product includes all the same features as the Merlin but with a sleek ergonomic design.

Merlin Plus offers the same advanced features as the Merlin but is compatible with most computer workstations and offers a split screen mode. This mode lets the user view magnified images and computer files concurrently.



enhanced vision

The Acrobat LCD video magnifier is designed to enlarge and enhance images to improve the lives of people who have low vision. The extent to which the Acrobat LCD can improve the ability to see images and text depends on a person's individual condition and level of visual impairment. The Acrobat LCD is not designed to restore vision, correct eye conditions or halt degenerative vision loss. An eye care professional can best determine the suitability of the Acrobat LCD for a patient's specific condition. For more information, please visit www.enhancedvision.com.

www.enhancedvision.com
(800) 440-9476 (US Office, toll free)
(714)465-3400 (US Office)
+44 (0) 9442317 (UK Office)
+49 (0)6691 911588 (DE Office)



Part # MAN-0002-00 Rev. X2
December, 2010

Copyright © 2009 by Enhanced Vision. All rights reserved.
Product specifications subject to change without prior notice.